

Article number: 54810632072

Description: 4 hole Flange Unit TP-SUCF207 for shaft $\varnothing 35\text{mm}$
Insert stainless steel, housing Thermoplastic white

Measures

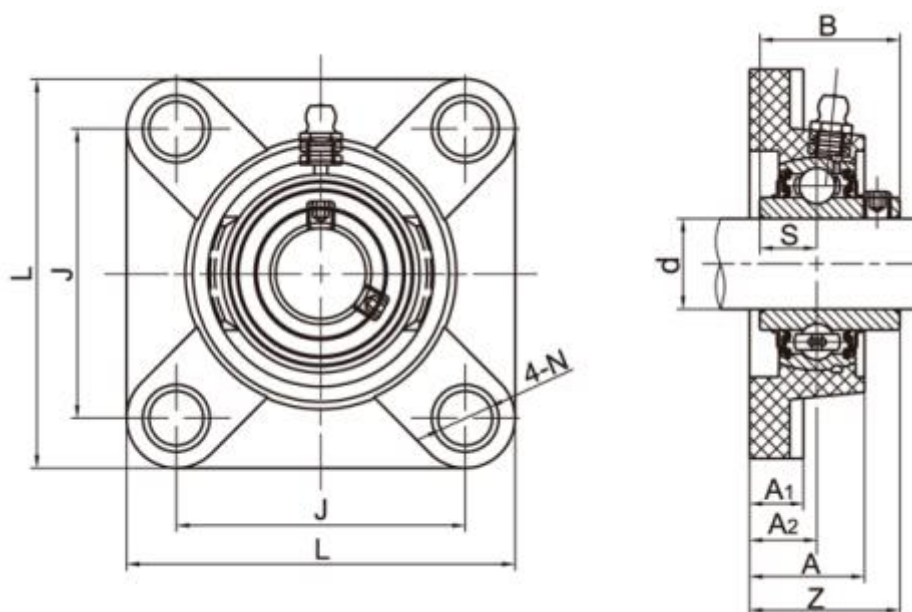

A = 34.8	N = 13
A1 = 15.5	S = 17.5
A2 = 21.5	Z = 46.9
B = 42.9	
Bolt = M12	
d = 35	
J = 92	
L = 118	